



460 Southport Commerce Blvd.
 Spartanburg SC 29306
 Phone: 864-574-6004
 Fax: 864-574-6005
 www.ojedausa.com
 sales@ojedausa.com

Project: _____
 Model #: _____
 Item #: _____ Qty: _____
 Approval: _____

ICE CREAM FREEZERS

NB-28



ADJUSTABLE THERMOSTAT
 Freezers are equipped with a mechanical thermostat that allows the users to adjust temperature that best fits their products needs. Set from factory at -4°F.

STEEL CONSTRUCTION
 Robust steel construction minimizes the use of plastic materials resulting in an environmental friendly design.

HEAVY DUTY CASTERS
 Equipped with durable casters that allow easy and fast movement in the store.

HIGH IMPACT ABS FRAME
 Made of a high impact durable plastic, this frame assures a long-term life span.

TOP LIGHT BAR
 Optional top light bar for custom graphics.

OPERATING TEMPERATURE
 -10°-0°F

CUSTOM GRAPHICS
 Standard color: white

Dimensions			Crated Dimensions			Baskets	HP	Voltage	NEMA config	Amps	Crated Weight
W	D	H	W	D	H	2	1/5	120	5-15P	2.0	150 lbs
(in) 28.1	26.3	37	(in) 31	29	39	Net Capacity (cf): 6.89			Energy Consumption: 1.367		
(mm) 713	668	939	(mm) 787	736	990						

*Specifics may change without notification



CABINET CONSTRUCTION

- High-density, CFC-Free, polyurethane insulation
- Low-E tempered sliding glass lids with lock and keys
- High impact ABS top frame
- Exterior: galvanized metal cabinet with powder coated painted surface
- Interior: easy to clean pre-painted steel
- Heavy duty casters
- Drain plug for easy cleaning
- Holds 8-3 gallon tubs
- Stores 6-3 gallon tubs in bottom

OPERATING CONDITIONS

- The unit is best suited for an environment where temperatures remain below 85 F and humidity does not exceed 55%
- Areas with direct sunlight should also be avoided

OPTIONS

- Two ring tub holders
- Top light bar
- Removeable Baskets

REFRIGERATION

- Maintenance free condenser
- Adjustable thermostat
- Easy to reach components for repairs
- Triple access air flow compressor compartment

WARRANTY

- 3 year parts and labor warranty
- 5 year compressor part

HEAVY DUTY CASTERS



TOP LIGHT BAR



RING TUB HOLDERS

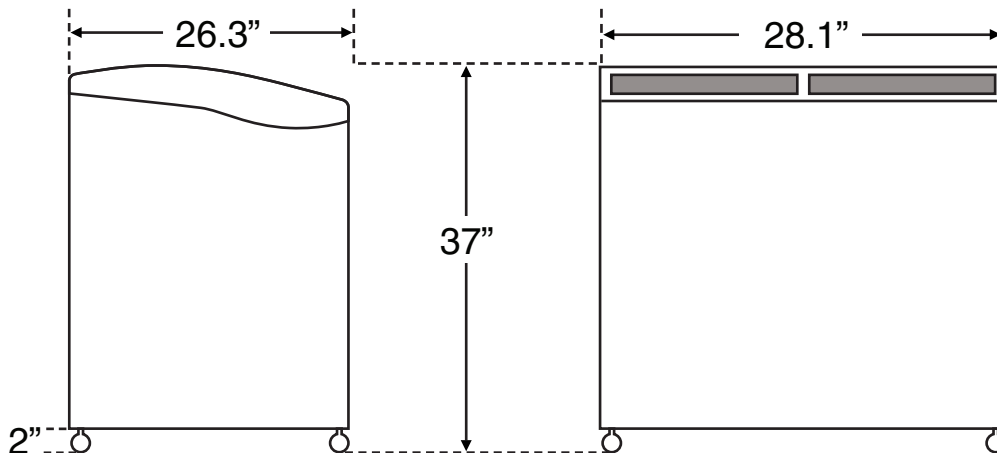
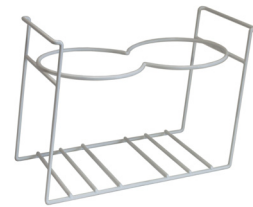

*Specifics may change without notification

